



MATICA MB D.O.O.

VAŠ NAJBOLJŠI DOBAVITELJ
vaš najboljši partner



RAZPORNE MATICE ORODJA ZA RAZPORNE MATICE



2012

www.maticamb.si

O NAS

Podjetje **Matica MB d.o.o.** je med vodilnimi dobavitelji pritrtilne tehnike v Sloveniji in na trgu Zahodnega Balkana. Naši izdelki so primerni predvsem za proizvodnjo v kovinski, elektro, avtomobilski, računalniški in strojni industriji. Podjetje je bilo ustanovljeno leta 2006 s prvotnim imenom MATICA BIN d.o.o. in se je v letu 2008 reorganiziralo v novo podjetje MATICA MB d.o.o. s sedežem v Domžalah.

Sistem poslovanja je osnovan z direktno povezavo najboljših proizvajalcev v Evropi brez vmesnih posrednikov. S tem dosegamo ugodne cene, kontrolo kvalitete izdelkov in dobro strokovno podporo našim strankam. Naši dobavitelji in proizvajalci prihajajo iz držav EU (Anglija, Italija, Nemčija).

Ponudba je specializirana predvsem na segment pritrtilne tehnike (slepe matice, slepe kovice, privarilne vijake, vtisne vijake, vtisne matice, matice v kletki...), vijačni material (vse vrste po DIN standardu-predvsem A2 IN A4), ORODJA za pritrtilno tehniko (pnevmatska, baterijska, ročna) in za vijačni material (pnevmatska, električna – kotna, ravna), ter za nestandardne specialne zahteve naših kupcev (pritrtilna tehnika, vijačni material), kjer vam naši kooperantje izdelajo artikel vseh vrst dimenzij in materiala. Za vsa orodja imamo tudi hiter in učinkovit servis.

Cilj našega poslovanja ni samo prodaja, ampak tudi pomoč pri rešitvah za izboljšanje vaših storitev v procesu pritrjevanja in vijačenja, kjer je zahtevana in potrebna visoka kvaliteta.

KONTAKT

Matica MB d.o.o
Aškerčeva ulica 17A,
1230 Domžale

PE Špruha 44, 1236 Trzin

T +386 59 958 319
F +386 1 721 1439
E maticamb@maticamb.si

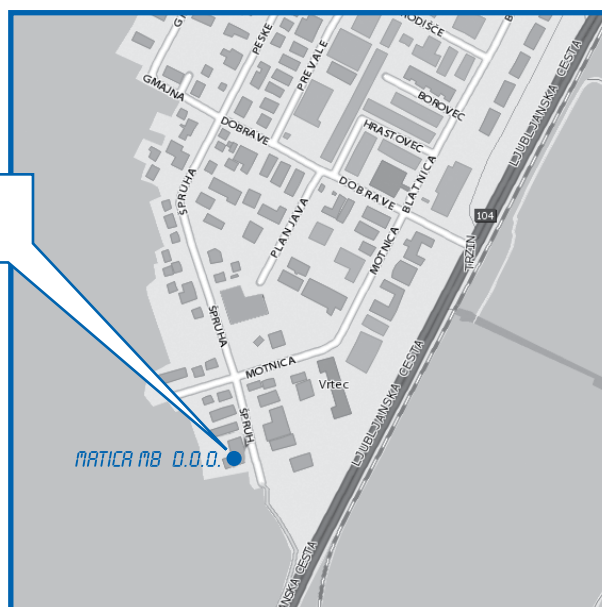

SPLOŠNO O RAZPORNIH MATICAH

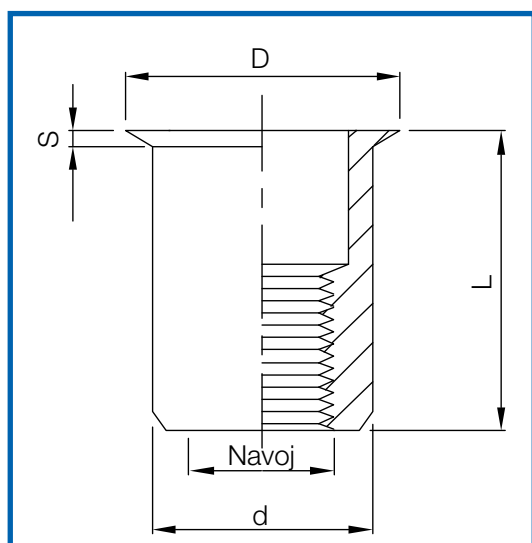

Oznake

- D = premer glave
- S = debelina glave
- L = dolžina
- d = zunanji premer
- Navoj = premer metričnega navoja

Oznake glav razpornih matic

- VR = glava z velikim robom
- MR = glava z malim robom
- VV = vgrezna glava

Oblike razpornih matic

- = okrogla
- H = 6-ogлата (hexa)
- P = pol 6-ogлата

Odrpte ali zaprte razporne matice

- O = odprta
- Z = zaprta

Oznake materialov razpornih matic

- = cinkano jeklo
- N = nerjaveče jeklo
- A = aluminij

Dodatno

- N = narebričena

Primer:

NVVO-N = nerjaveče jeklo, okrogla vgrezna glava, odprta, narebričena

Druge razporne matice:

- NPTC = okrogla, odprta, neoprenska
- JKF (JKI) = za nekovinske materiale
- FRT = trilobatna
- BFTC = kovični vijak

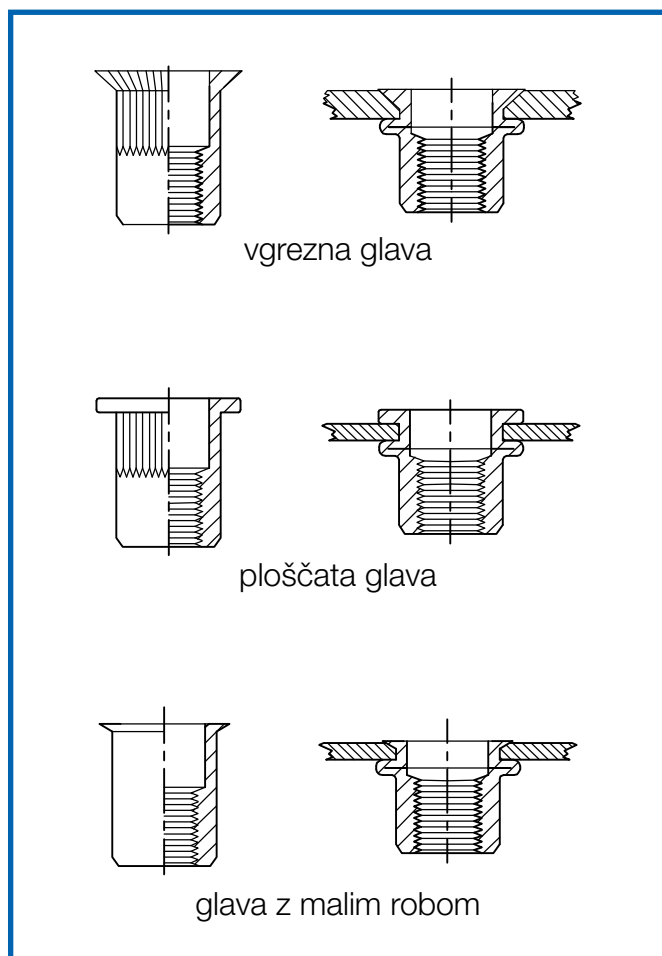

Odprte ali zaprte razporne matice

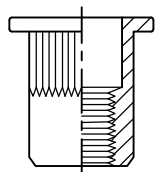

odprte

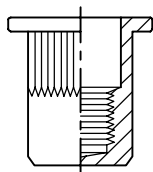

zaprte

Oblike razpornih matic

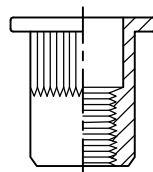

okrogla

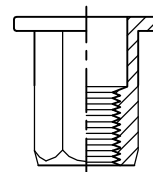

6-oglata

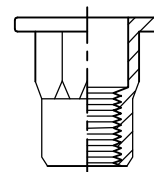

pol 6-oglata

		za delo z			
		aluminijem	bakrom	jeklom	nerjavečim jeklom
material kovičnih matic	aluminij	✓	✘	○	○
	jeklo	○	✘	✓	✓
	nerjaveče jeklo	○	○	✓	✓

Oznake

- ✓ v redu
- sprejemljivo
- ✘ slabo

RAZPORNE MATICE

Cinkane: gladke / narebričene in odprte / zaprte



VRO*



VVO*



MRO*



VRHO



MRHO



VRZ



VZ*



VRHZ

Nerjaveče: gladke / narebričene



NVRO*



NVVO



NMRO*



NMRZ

Aluminij:



AVRO



AVVO



AVRZ



AVVZ

Drugo:



NPTC



JKF



BFTC



Trilobatna

* na sliki narebričena izvedba (-N)

TABELE



razporne matice **okrogla; glava z velikim robom; odprta, gladka / narebričena;**
cinkane / nerjaveče jeklo / aluminij

Navoj	uporabni razpon (mm)	premer glave (mm)	debelina glave (mm)	premer izvrtine (sveder M)	Koda Matica MB
M3	0,5-2,0	7,0	0,8	5	03-1113/MB VRO 03-1713/MB VRO-N 03-5008/MB NVRO-N
M4	0,5-2,0	8,5	0,8	6	03-1114/MB VRO 03-1714/MB VRO-N 03-5011/MB NVRO-N
M5	0,5-2,5	10,0	1,0	7	03-1115/MB VRO 03-1715/MB VRO-N 03-5012/MB NVRO-N
M6	0,5-3,0	13,0	1,3	9	03-1116/MB VRO 03-1716/MB VRO-N 03-5013/MB NVRO-N
M8	0,5-3,5	15,0	1,5	11	03-1117/MB VRO 03-1717/MB VRO-N 03-5014/MB NVRO-N 03-5015/MB NVRO
M10	0,5-3,0	19,0	2,1	13	03-1118/MB VRO 03-1718/MB VRO-N
M12	1,0-4,0	23,0	2,1	16	03-1120/MB VRO 03-1719/MB VRO-N



razporne matice **okrogla, glava z velikim robom, zaprta, gladka / narebričena;**
cinkane / nerjaveče jeklo / aluminij

Navoj	uporabni razpon (mm)	premer glave (mm)	debelina glave (mm)	premer izvrtine (sveder M)	Koda Matica MB
M4	0,5-2,0	9,0	0,8	6	03-1214/MB VRZ 03-1814/MB VRZ-N
M5	0,5-3,0	10,0	1,0	7	03-1215/MB VRZ 03-5035/MB NVRZ
M6	0,5-3,0	12,0	1,5	9	03-1216/MB VRZ 03-1816/MB VRZ-N 03-5037/MB NVRZ
M8	0,5-3,0	15,0	1,5	11	03-1217/MB VRZ 03-1817/MB VRZ-N 03-5039/MB NVRZ
M10	0,8-3,5	17,0	1,5	13	03-5041/MB NVRZ



razporne matice **okrogla; vgrezna glava, odprta; gladka / narebričena;**
cinkane / nerjaveče jeklo / aluminij

Navoj	uporaben razpon (mm)	premer glave (mm)	debelina glave (mm)	premer izvrtine (sveder M)	Koda Matica MB
M4	1,5-3,0	9,0	1,5	6	03-1914/MB VVO-N
M5	1,5-3,5	10,0	1,5	7	03-1915/MB VVO-N 03-5111/MB NVVO-N 03-5112/MB NVVO
M6	1,5-4,0	12,0	1,5	9	03-1317/MB VVO 03-1916/MB VVO-N 03-5114/MB NVVO-N
M8	2,0-4,5	14,0	1,5	11	03-1917/MB VVO-N 03-5116/MB NVVO 03-5117/MB NVVO-N
M10	2,0-5,0	16,0	1,5	13	03-1920/MB VVO-N 03-5119/MB NVVO



razporne matice **okrogla; vgrezna glava; zaprta; gladka;**
cinkane

Navoj	uporaben razpon (mm)	premer glave (mm)	debelina glave (mm)	premer izvrtine (sveder M)	Koda Matica MB
M4	1,5-3,0	9,0	1,5	6	03-1414/MB VVZ
M5	1,5-3,5	10,0	1,5	7	03-1413/MB VVZ
M6	1,5-4,0	12,0	1,5	9	03-1416/MB VVZ
M8	2,0-4,5	14,0	1,5	11	03-1417/MB VVZ



razporne matice **okrogla; glava z malim robom; odprta; gladka / narebričena;**
cinkane / nerjaveče jeklo

Navoj	uporaben razpon (mm)	premer glave (mm)	debelina glave (mm)	premer izvrtine (sveder M)	Koda Matica MB
M3	0,5-2,0	6,0	0,5	5	03-2213/MB MRO-N
M4	0,5-2,0	7,0	0,5	6	03-1514/MB MRO 03-2214/MB MRO-N 03-5514/MB NMRO-N
M5	0,5-2,0	8,0	0,5	7	03-1515/MB MRO 03-2215/MB MRO-N 03-5515/MB NMRO-N
M6	0,5-2,5	10,5	0,6	9	03-1516/MB MRO 03-2216/MB MRO-N 03-5516/MB NMRO-N
M8	0,5-3,0	12,0	0,7	11	03-1517/MB MRO 03-2217/MB MRO-N 03-5517/MB NMRO-N
M10	0,5-3,0	14,5	1,0	13	03-1520/MB MRO 03-2218/MB MRO-N 03-5519/MB NMRO-N



razporne matice **okrogla; glava z malim robom; zaprta; gladka / narebričena;**
cinkane / nerjaveče jeklo

Navoj	uporabni razpon (mm)	premer glave (mm)	debelina glave (mm)	premer izvrtine (sveder M)	Koda Matica MB
M4	0,5-2,0	6,5	0,5	6	03-2314/MB MRZ-N 03-5704/MB NMRZ
M5	0,5-3,0	7,5	0,5	7	03-2315/MB MRZ-N 03-5705/MB NMRZ
M6	0,5-3,0	9,5	0,5	9	03-2316/MB MRZ-N 03-5706/MB NMRZ
M8	0,5-3,0	11,5	0,5	11	03-2320/MB MRZ-N 03-5708/MB NMRZ



razporne matice **6-oglate; glava z velikim robom; odprta;**
cinkane / nerjaveče jeklo

Navoj	uporabni razpon (mm)	premer glave (mm)	debelina glave (mm)	Širina luknje (mm)	Koda Matica MB
M4	0,5-2,0	9,0	0,8	6,0	03-2414/MB VRHO
M5	0,5-2,5	10,0	1,0	7,0	03-2415/MB VRHO
M6	0,5-3,0	12,5	1,6	9,1	03-2416/MB VRHO
M8	1,0-3,5	16,0	1,5	11,0	03-2417/MB VRHO
M10	1,0-4,0	16,5	2,1	13,1	03-2418/MB VRHO



razporne matice **6-oglate, glava z velikim robom; zaprta;**
cinkane / nerjaveče jeklo

Navoj	uporabni razpon (mm)	premer glave (mm)	debelina glave (mm)	Širina luknje (mm)	Koda Matica MB
M4	0,5-2,0	9,0	1,0	6,0	03-2513/MB VRHZ
M5	0,5-3,0	10,0	1,0	7,0	03-2514/MB VRHZ
M6	0,5-3,0	12,7	1,5	9,0	03-2516/MB VRHZ
M8	1,0-3,5	16,0	1,5	11,0	03-2517/MB VRHZ



razporne matice **6-oglate; pol 6-oglate; glava z malim robom; odprta;**
cinkane / nerjaveče jeklo

Navoj	uporabeni razpon (mm)	premer glave (mm)	debelina glave (mm)	Širina luknje (mm)	Koda Matica MB
M4	0,5-2,0	7,0	0,5	6,0	03-2614/MB MRHO 03-2662/MB NMRHO-P
M5	0,5-2,5	8,0	0,5	7,0	03-2615/MB MRHO 03-2664/MB NMRHO-P
M6	0,5-3,0	10,0	0,6	9,0	03-2616/MB MRHO 03-2666/MB NMRHO-P
M8	1,0-3,5	12,0	0,7	11,0	03-2617/MB MRHO 03-2667/MB NMRHO-P
M10	1,0-3,5	14,5	0,8	13,0	03-2618/MB MRHO



razporne matice **6-oglate; glava z malim robom: zaprta;**
cinkane

Navoj	uporabeni razpon (mm)	premer glave (mm)	debelina glave (mm)	Širina luknje (mm)	Koda Matica MB
M4	0,5-2,0	7,0	0,6	6,0	03-2714/MB MRHZ
M5	0,5-3,0	8,0	0,7	7,0	03-2715/MB MRHZ
M6	0,5-3,0	10,0	0,7	9,0	03-2716/MB MRHZ
M8	1,0-4,0	12,0	0,7	11,0	03-2718/MB MRHZ



razporne matice cinkane / nerjaveče jeklo / aluminij / PVC

Drugo

Izdelek	Navoj	Premer glave (mm)	dolžina l (mm)	debelina glave (mm)	POKLČI
Trisert (FRT)	M3-M10	5,2-15,0	9,0-18,5	0,4-0,7	
Rivbolt (BFTC)	M4-M8	5,4-9,8	10,0-20,0	0,5-1,0	
NPTC	M3-M12	11,0-27,0	12,6-80,0	0,9-5,7	
JKL / JKI	M5-M8		18,0-25,2		

Podatki so informativni. Pridržujemo si pravico do sprememb

ORODJA ZA RAZPORNE MATICE

RIV912



Uporaben razpon: **M3-M12**
 Hod (mm): **1,0-6,5**
 Delovni pritisk (bar): **5-7**
 Teža (kg): **2,3**

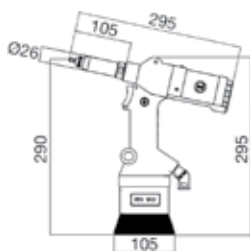

RIV938S



Uporaben razpon: **M3-M6**
 Hod (mm): **6,5**
 Delovni pritisk (bar): **5-7**
 Teža (kg): **1,7**

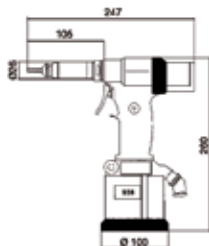

RIV998



Uporaben razpon: **M3-M12**
 Hod (mm): **0-6,5**
 Delovni pritisk (bar): **5-7**
 Teža (kg): **2,4**

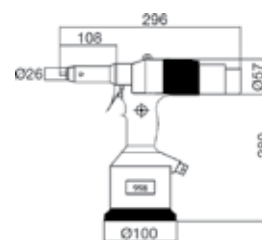

RIV990



Uporaben razpon: **M4-M8**
 Hod (mm): **6,0**
 Delovni pritisk (bar): **5-7**
 Teža (kg): **2,3**

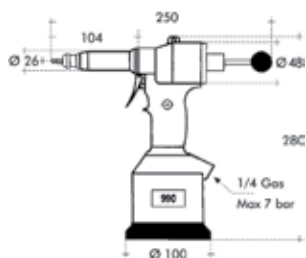

RIV790



Uporaben razpon: **M3-M10**
 Hod (mm): **20**
 Napetost (V): **14,4**
 Teža (kg): **2,0**

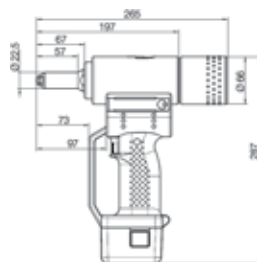

RIV905



Uporaben razpon: **M3-M12**
 Hod (mm): **90**
 Teža (kg): **1,7**

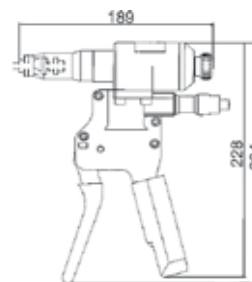

Ročna orodja

RIV900

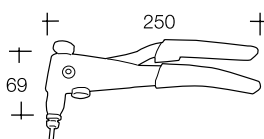

RIV901

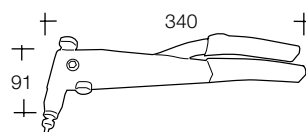

RIV903

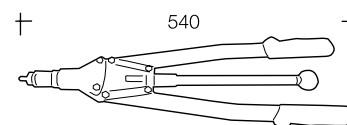

Primerjalna tabela orodij

Orodje	uporaben razpon	dolžina (mm)	teža (kg)	hod (mm)	delovni pritisk (bar)
RIV912	M3-M12	295	2,3	1,0-6,5	5 - 7
RIV938S	M3-M6	187	1,7	6,5	5 - 7
RIV998	M3-M12	296	2,4	0,0-6,5	5 - 7
RIV990	M4-M8	250	2,3	6,0	5 - 7
RIV790	M3-M8	217	2,0	20,0	-
RIV900	M3-M5	250	0,9	-	-
RIV901	M4-M8	340	0,9	-	-
RIV903	M3-M10	540	2,2	-	-
RIV905	M3-M12	189	1,7	9,0	-

Nadomestni deli



Samo učinkovit sistem zagotavljanja in dobave rezervnih delov lahko omogoča podjetju ustrezno produktivnost in kakovost delovanja. Prav tako predstavlja ključno podporo k izvajanju vzdrževalnih del, servisnih popravil, servisnim mrežam in ostalim procesom v podjetju. Zagotavljanje nadomestnih delov in servisnih storitev v zahtevanem času je vodilo podjetja Matica MB.

Za vsa orodja vam med in po izteku garancijskega roka zagotavljamo možnost nabave originalnih nadomestnih delov in možnost koriščenja servisnih uslug, ki vam bodo zagotovili normalno delovanje proizvoda ob normalni rabi in vzdrževanju.



MATICA MB 0.0.0.

VAŠ NAJBOLJŠI DOBAVITELJ
vaš najboljši partner



KOVČNI
MATERIAL

VIJČNI
MATERIAL



ORODJA

SERVIS



PRIVARILNI
ELEMENTI

VTISNI
ELEMENTI



WWW.MATICAMB.SI