



**before welding**



**after welding**



### Insulation Pins IS

$d_1$	3	4	5	6
$l_2 \pm 0,5^{*)}$	weight about (7,85 kg/dm <sup>3</sup> ) per 1.000pcs in kg (St.37)			
35	1,95	3,47	5,43	7,82
40	2,23	3,97	6,20	8,93
45	2,51	4,47	6,98	10,05
50	2,79	4,96	7,76	11,17
55	3,07	5,46	8,53	12,29
60	3,35	5,96	9,31	13,40
70	3,91	6,95	10,86	15,64
80	4,47	7,94	12,41	17,87
90	5,03	8,93	13,96	20,10
100	5,58	9,93	15,51	22,34
200	11,17	19,85	31,02	44,67
300	16,75	29,78	46,53	67,01
400	22,34	39,71	62,05	89,35
500	27,92	49,64	77,56	11,68

\*) other length according agreement

Material selection: Other materials according agreement

ISO-Standard	4.8	A2-50	A4-50
Old Description	St. 37 verk.	1.4301	1.4571
Product Key	41-0X-7XXX	42-0X-7XXX	48-0X-7XXX

Ordering sample IS 3x35 of A2-50 = Art.-Nr.: 42-03-7035

**before welding**



**after welding**



### Insulation Pins IS-DS

$d_1$	3	4	5	6
$l_2 \pm 0,5^{*)}$	weight about (7,85 kg/dm <sup>3</sup> ) per 1.000pcs in kg (St.37)			
35	1,95	3,47	5,43	7,82
40	2,23	3,97	6,20	8,93
45	2,51	4,47	6,98	10,05
50	2,79	4,96	7,76	11,17
55	3,07	5,46	8,53	12,29
60	3,35	5,96	9,31	13,40
70	3,91	6,95	10,86	15,64
80	4,47	7,94	12,41	17,87
90	5,03	8,93	13,96	20,10
100	5,58	9,93	15,51	22,34
200	11,17	19,85	31,02	44,67
300	16,75	29,78	46,53	67,01
400	22,34	39,71	62,05	89,35
500	27,92	49,64	77,56	11,68

\*) other length according agreement

Material selection: Other materials according agreement

ISO-Standard	4.8	A2-50	A4-50
Old Description	St. 37 verk.	1.4301	1.4571
Product Key	41-0XX-6XXX	42-0XX-6XXX	48-0XX-6XXX

Ordering sample: IS-DS 3x35 of A2-50 = Art.No. 42-003-6035

before welding

after welding



## Insulation Pins IS-MS

$d_1$	3	4	5	6
$l_{2 \pm 0,5}^{*)}$	weight about (7,85 kg/dm <sup>3</sup> ) per 1.000pcs in kg (St.37)			
35	1,95	3,47	5,43	7,82
40	2,23	3,97	6,20	8,93
45	2,51	4,47	6,98	10,05
50	2,79	4,96	7,76	11,17
55	3,07	5,46	8,53	12,29
60	3,35	5,96	9,31	13,40
70	3,91	6,95	10,86	15,64
80	4,47	7,94	12,41	17,87
90	5,03	8,93	13,96	20,10
100	5,58	9,93	15,51	22,34
200	11,17	19,85	31,02	44,67
300	16,75	29,78	46,53	67,01
400	22,34	39,71	62,05	89,35
500	27,92	49,64	77,56	11,68

\*)other length according agreement

Material selection: Other materials according agreement

ISO-Standard	4.8	A2-50	A4-50
Old Description	St. 37 verk.	1.4301	1.4571
Product Key	41-0XX-1XXX	42-0XX-1XXX	46-0XX-1XXX

Ordering sample: IS-MS of A2-50 = Art. No. 42-003-1035

before welding

after welding

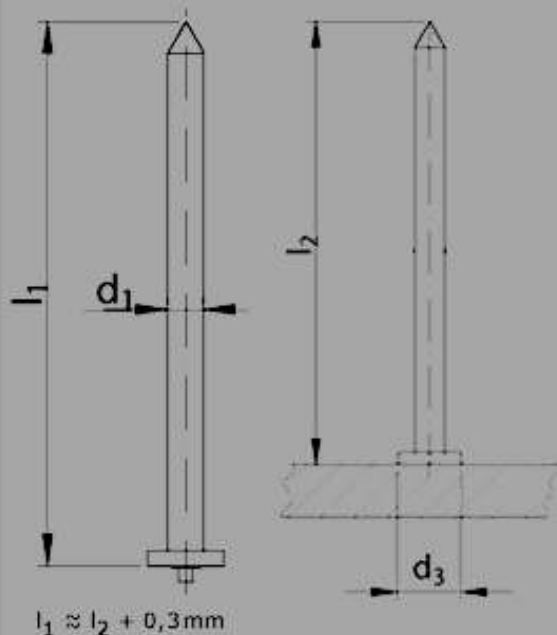

## Insulation Pins ISN

$d_1$	2	2,5	3
$l_{2 \pm 0,5}^{*)}$	weight about (7,85 kg/dm <sup>3</sup> ) per 1.000pcs in kg (St.37)		
15	0,360	0,590	0,760
20	0,500	0,800	1,040
25	0,630	1,010	1,310
30	0,770	1,210	1,590
40	1,040	1,630	2,150
50	1,310	2,050	2,700
60	1,590	2,460	3,260
70	1,860	2,880	3,810
80	2,130	3,300	4,360
100	2,670	4,130	5,470

\*)other length according agreement

Material selection: Other materials according agreement

ISO-Standard	4.8	A2-50	AlMg 3	A4-50
Old Description	St. 37 verk.	1.4301	Aluminium	1.4571
Product Key	41-0XX-0XXX	42-0XX-0XXX	44-0XX-0XXX	48-0XX-0XXX

Ordering sample: ISN 2x15 of A2-50 = Art.Nr. 42-002-0015

before welding

after welding



## VBS

$d_1$	3
$d_2$	6
$d_3$	7,5
$l_3$	15
$l_2$	ca. weight per 1.000pcs in kg
35	2,68
45	3,23
50	3,51
60	4,07
70	4,63
90	5,75
100	6,30
110	6,86
120	7,42
140	8,54
160	9,66
180	10,77
200	11,89
250	14,68

1) other length according agreement

Material selection: Other materials according agreement

ISO-Standard	4.8	A2-50	A4-50
Old Description	St. 37 verk.	1.4301	1.4571
Product Key	41-0XX-4XXX	42-0XX-4XXX	48-0XX-4XXX

Ordering sample: VBS 3x35 of A2-50 = Art.No:42-003-4035

before welding

after welding

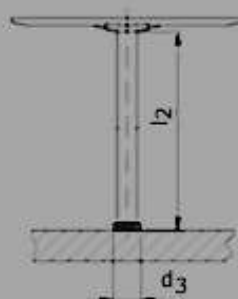
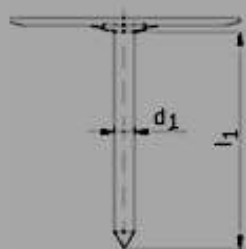

## Cupped head Pins

d	30
$d_1$	2
$l_1$	weight about (7,85 kg/dm <sup>3</sup> ) per 1.000pcs in kg (St. 37)
19,1	2,7
25,4	2,8
28,6	2,9
38,1	3,1
47,6	3,4
54,0	3,5

1) other length according agreement

Material selection: Other materials according agreement

ISO-Standard	4.8	A2-50	A4-50
Old Description	St. 37 verk.	1.4301	1.4571
Product Key	41-0XX-5XXX	42-0XX-5XXX	48-0XX-5XXX

Ordering sample : Cupped head Pin 2x19,1 of A2-50 = Art.No:42-003-4035